

(Model 2588)

Electric Heater Fire

User / Installation Instructions



These instructions should be read carefully and retained for future reference.

CONTENTS

1. Important Notes	1-2
2. Technical Specification / Parts List	3
3. Parts List	4
4. Fire Installation	5 - 6
5. Trim Installation	7
6. Operation By Manual Control	8
7. Operation By Remote Control	9 - 13
8. Maintenance	14
9. Electric Fire Guarantee	15
10. Others	16

IMPORTANT NOTES

- **Read all of the instructions carefully before using the appliance.**
- **For indoor use only.** This appliance is not suitable for use outside the house and **only suitable for well insulated spaces or occasional use.**
- If the fire is to be placed in front of an existing chimney opening and there is any risk of chimney debris falling down onto the fire or drafts from the chimney it is recommended that the flue or opening is sealed off with non-combustible non-fibrous insulation materials. Do not place into an existing fireplace that is prone to dampness. Should it be necessary to cap and seal the chimney to prevent personal injury, a professional should be hired to do the work
- Do not use this appliance in the immediate surroundings of a bath, a shower or a swimming pool.
- Do not use this fire as a free-standing appliance. It must always be fixed to the wall, fireplace mantel, floor etc.
- This fire must not be located immediately below a socket-outlet.
- This appliance must not be supplied through an external switching device, such as a timer, or connected to the circuit that is regularly switched on and off by utility in order to avoid a hazard due to the inadvertent resetting of the thermal cut out.
- A non-rewirable plug fitted with a 13A fuse is supplied. Should the fuse or plug need replacing, and you are competent to do so, it must be replaced with a 13A fuse or plug being 13A BS1363A approved.
- If the power cord is damaged, it must be repaired by the manufacturer, its authorised service centre or professional person.
- **Do not cover:** warning: in order to avoid overheating, do not cover the appliance.
- To reduce the risk of fire, keep textiles, curtains, or any other flammable material a minimum distance of 1 meter from the air outlet.
- Keep the power cord away from hot surfaces and hot conditions. Do not route the power lead in front of the appliance.
- Do not use this fire in rooms that have explosive gas in them (for example petrol), or if you are using solvents, glue, aerosol spray or in flammable paints, as these may catch fire.
- This appliance can be used by children aged from 8 years and above and persons with reduced physical, sensory or mental capabilities or lack of experience and knowledge if they have been given supervision or instruction concerning use of the appliance in a safe way and understand the hazards involved.

- Children shall not play with the appliance.
- Cleaning and user maintenance shall not be made by children without supervision.
- Children of less than 3 years should be kept away unless continuously supervised.
- Children aged from 3 years and less than 8 years shall only switch on/off the appliance provided that it has been placed or installed in its intended normal operating position and they have been given supervision or instruction concerning use of the appliance in a safe way and understand the hazards involved. Children aged from 3 years and less than 8 years shall not plug in, regulate and clean the appliance or perform user maintenance
- Caution: some part of this appliance can become very hot and cause burns. Particular attention has to be given where children and vulnerable people are present
- This appliance must be positioned so that the plug/fused spur is accessible.
- In the event of a fault please disconnect the fire from the mains supply.
- Warning: This appliance must be earthed.
- Keep the power plug accessible after installation.

TECHNICAL SPECIFICATION

Model No.: 2588

Supply Voltage: AC 230-240V 50Hz

Maximum power consumption: 2KW

Power for flame effect: 8.8W (LED 4.8W + Motor for flame 4W)

Heat Output:

Nominal heat output (Pnom): 2KW

Minimum heat output (indicative) (Pmin): 1KW

Maximum continuous heat output (Pmax): 2KW

Auxiliary Electricity Consumption:

At nominal heat output (elmax): 12.5W

At minimum heat output (elmin): 12W

In standby mode (elSB): 0.48W

Type of heat output / room temperature control

Single stage heat output and no room temperature control	No
Two or more manual stages, no room temperature control	No
With mechanic thermostat room temperature control	No
With electronic room temperature control	Yes
Electronic room temperature control plus day timer	Yes
Electronic room temperature control plus week timer	Yes

Other Control Options

Room temperature control, with presence detection	No
Room temperature control, with open window detection	Yes
With distance control option	No
With adaptive start control	Yes
With working time limitation	No
With black bulb sensor	No

PARTS LIST

Please unpack carefully ensuring that any loose parts and all packing items are removed. Read any warning labels carefully (see Maintenance Section). Place waste packaging back into the box and dispose of RESPONSIBLY.

1 Remote Control	1pc
2 AAA Batteries	2pcs
3 Instruction Manual	1pc
4 Flat Trim Cover	1pc
5 Curved Trim Cover	1pc

FIRE INSTALLATION

Dimension

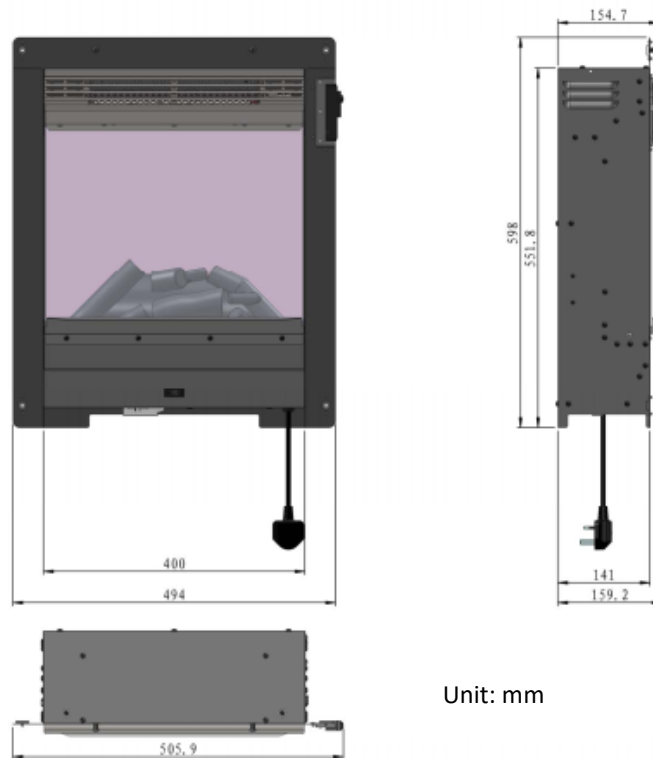

Before You Start

- The appliance Data Plate is located on the rear of the fire.
- Required for installation: 4 off screws and plugs suitable for the wall media (Not supplied).
- The surround / appliance must be positioned so that plug (fused spur) is accessible. Only when you are certain that you have completed the installation should you plug in and switch on at the wall socket.
- This fire should not be installed into an open / existing fireplace without the opening being professionally blanked off to reduce the risk of a back draught, which could cause the safety cut-out to operate.
- Check that the supply voltage details on your flame effect fire are in accordance with your electrical supply. Your fire is fitted with a plug incorporating a 13 Amp fuse. In the event of replacing the fuse in the plug, a 13 Amp fuse approved by ASTA to BS 1362 must be used. Before switching on, please read the following fire installation instructions.

Fire Installation

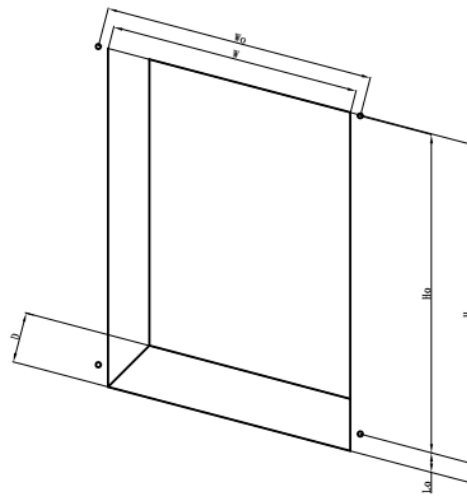

(unit: mm)

Opening Size For Insert			Positions for Fixing Screw		
W	D	H	W _o	H _o	L _o
413	≥145	565	465	545	33.5

- Ensure that the mains power is isolated to the fire plug / socket point.
- Offer the fire into the opening.
- Mark on the wall the positions of the fixing points on the side flanges of the fire.
- Remove the fire from the opening.
- Drill and plug the wall holes using suitable fixings.
- Connect the fire to the plug / socket.
- Offer the fire back into the opening and using suitable screws fix the fire in position.
- Using the magnets on the fire fit the trim into position.
- Restore power to the plug / socket.

Trim Installation

Flat Trim

- Fix the flat cover to the lower of the fireplace.
- Use four magnets to secure the trim to the fireplace.



Curved Trim

- Fix the curved cover to the lower of the fireplace.
- Lower the cast trim onto the two fixing screws located at the top of the fire.

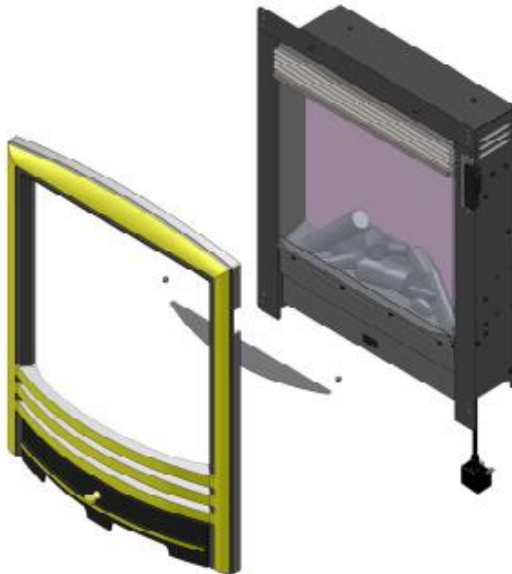

OPERATION BY MANUAL CONTROL

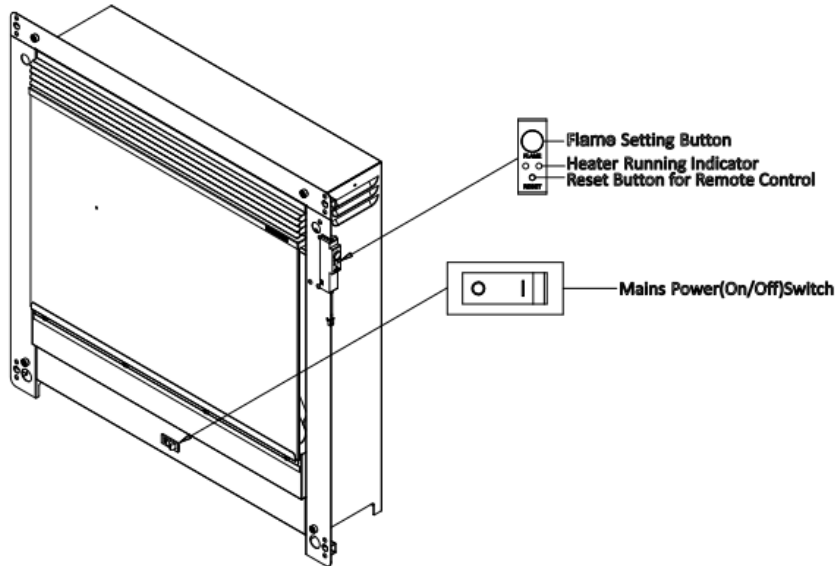

NOTE: The manual button controls basic functions, not a full range of controls. Use the remote handset to carry out all functions.

The manual buttons are located on the appliance as showed in the picture.

Press “FLAME” button to select the colour of flame (3 kinds) or return to the “OFF” position.

NOTE: The controls on appliance will lose the memory for all function settings when the switch is set to the “Off” Position. When the remote runs out of power or when you change the batteries, only the flame function will lose memory and will not affect the timer settings, however, the clock may need adjusting.

OPERATION BY REMOTE CONTROL

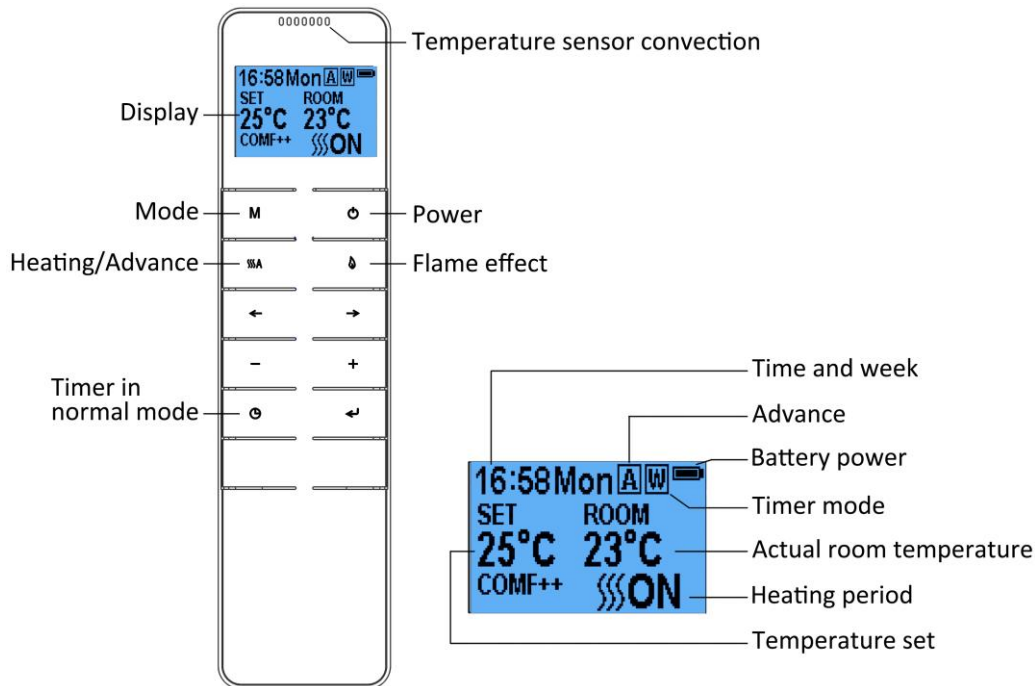

NOTE: This is thermostatic remote control. The remote should be in the same room as the fireplace and placed on a flat surface. It must be placed away from the fire so the hot air will not blow onto it and affect thermostatic reading.

The communication frequency between the fire and remote has already been set up. If you cannot use the remote with the fire, please follow instructions Step.R31 to initiate this connection.

Standby for Remote Handset

R1 The screen shown to the right is when the remote handset is in standby mode.



Before Day / Time set up

Turn on/off

R2 Press to turn on the flame effect or turn off the flame effect and heater when in normal mode.



After Day / Time set up

R3 Press to turn on / off the flame effect under daily and weekly timer mode.

Flame Effect

R4 Press to enter the flame effect adjustment screen.

R5 Press the '' and '' button to select the 3 Kinds of flame effect.



R6 Press the '' and '' button to select the 5 brightness of flame effect and OFF settings

Normal Mode

R7 Normal control mode is factory set. If it is not, then press **M** button until the logo **N** shows up at the upper right corner of the screen.

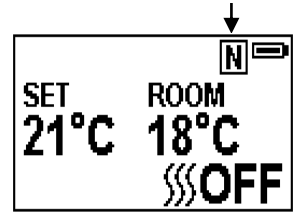

R8 Press the '+' or '-' button to adjust the temperature setting from 17°C to 25°C by 2 degree intervals.

R9 Press **⏏** **A** button to turn on / off the heat, **⏏**ON, **⏏**OFF will show at the lower of the screen.

NOTE: It is normal for the fan heater to stop running for periods of time. This happens because the room temperature is at or above the temperature set on the remote control. The heater indicator will be turned off after 10s if you have the flame ON. The heater indicator will stay ON if you use the heating function only.

Count Down Timer

NOTE: This setting is only for normal mode. It allows the appliance to go into standby after a set period of time.

R10 Press **⌚** to cycle through the settings from Off and 0.5 hours to 9 hours. The timer logo and time will show on the screen. **The heater must be in the ON position.**

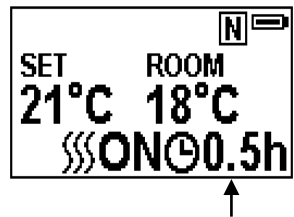

The heater can be automatically run by using daily timer and weekly timer on the remote.

Set up Day, Time and Comfortable temperature.

R11 Press **⏻** to turn on the remote handset. Hold the button **M** button for 3 seconds to enter the setting screen.

R12 Press the '←' or '→' button to choose Day, Time or your comfortable temperature. The character selected will be highlighted.

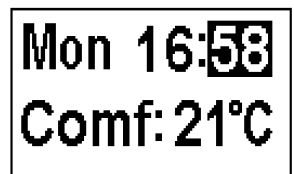

R13 Pressing the '+' or '-' button will adjust the number.

- Time: 24-hour system
- Select your comfortable temperature from 15-25°C.
- Temperature unit: °C、°F

Daily Timer Heating

R14 The following are pre-set heating periods, which can be altered if desired

06:00 until 08:30
17:00 until 22:00

R15 Press **M** until **D** shows at the upper right corner of the screen to enter into the daily timer heating mode.

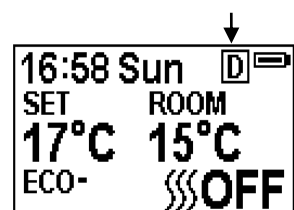

R16 Hold the arrow symbol button  for 6 seconds to enter the daily timer setting.
Max 3 timed Heating periods per day.

- Press '←' or '→' to choose hour or minute, press '+' or '-' to set the time.
- Minute will increase / decrease by 15 minutes per press.
- Hold  for 3 seconds or wait for 10 seconds to save and exit the heating time period setting.

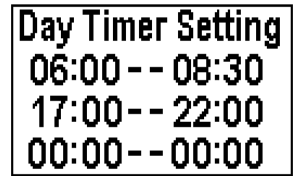

R17 Adjusting the set temperature

- Press the '+' or '-' button to increase or decrease the set temperature on the basis of your comfortable temperature setting.
- ECO means 2°C lower than your comfortable temperature setting,
ECO- means 4°C lower,
COMF+ means 2°C higher,
COMF++ means 4°C higher.

R18 To check your daily timer settings press  .

R19 If heating needs to be turned off, it will be necessary to go back to the Normal Mode to turn off.

Week Timer Heating



R20 The following are pre-set heating periods, which can be altered if desired.

From Monday to Friday	From Saturday to Sunday
06:00 until 08:30	06:30 until 09:30
17:00 until 22:00	11:00 until 13:00
	17:00 until 22:00

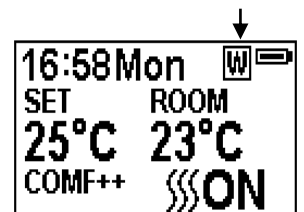
R21 Press **M** until  shows at the upper right corner of the screen to enter into the week timer heating mode.



R22 Hold  button for 6 seconds to enter the week timer setting

- Press '←' or '→' to move the cursor (a flashing underline), press the  button in the corresponding week position to select (the character is highlighted) or cancel (the character is displayed normally) the current setting. Several days can be selected together.
- Press the '→' button to move the cursor to the time period setting area. Press '←' or '→' to choose hour or minute, press '+' or '-' to set the number.
- Max 3 heating periods for a day.
- Minute will increase / decrease by 15 minutes per press.
- Press the  to set the heating time for the selected day(s) and return to the week line.
- Hold  for 3s or wait for 10s to save and exit the heating time period setting.

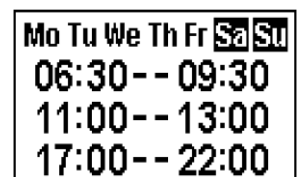
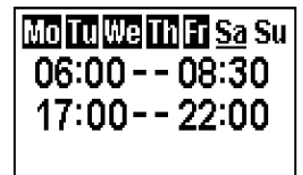

R23 Press ←, '←' or '→' to check your week Timer settings.

R24 If heating needs to be turned off, it will be necessary to go back to the Normal Control Mode to turn off

Advance Mode

R25 Under the daily and week timer mode Press ≡ A:

R26 To turn the heater off when the heater is on during a pre-set heating period

R27 To turn the heater on when the heater is off in between pre-set heating periods

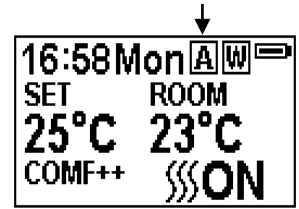

Adaptive Start Control

R28 According to room temperature and set temperature, the heater will automatically come on in time to heat the room to the set temperature at the set time. For example, if your timer is set to start at 18:00 and temperature is set to 23°C, the fire will come on at 17:30 to ensure the room is 23°C at 18:00.

Window Open Detection

R29 When the transmitter detects a rapid drop in room temperature, it will be judged as a “Window Open”, the warning icon will be displayed and the heating will be turned off automatically.

R30 After the indoor temperature has risen or a manual override of the warning (by operating remote control) has been done, the fire will return to normal working state.



Set up the communication between the remote and appliance

R31 The below operations should be carried out before programming, when changing to a new remote or in the event the appliance cannot be controlled by the remote:

- Hold the reset button on the appliance for 3 seconds (pen Point may needed) until you hear 3 short beeps from the unit, release the button.
- Press the  button on the remote, the programming is finished when you hear 1 long beep from the appliance.

R32 Resetting the code for remote control is necessary if the appliance operates wrongly or the remote control does not operate correctly.

- Open the back cover of the remote control.
- Press the Reset button on remote handset.
- Follow the steps R31



Remote Control Battery Replacement

When the batteries are at full power, the battery symbol will show 

When the batteries are half full, the battery symbol will show 

When the batteries are out of power and need replacing immediately, the battery symbol will show 

Battery replacement is recommended after 1 year. The batteries are 1.5V alkaline AAA, batteries.

Dispose of old batteries at an appropriate recycling facility.

Safety Thermal Cut-out and Thermal Link:

This appliance is fitted with an Electric Safety Control (E.S.). This is a safety device, which switches off the fire if, for any reason the appliance overheats. The E.S. Control can only be re-set after the appliance has cooled down, in order to re-set the E.S. Control, proceed as follows:

- Switch off the appliance.
- Unplug from the wall socket
- Leave for approximately 15 minutes.
- Plug in switch on appliance and the E.S. Control will re-set.

Ensure that the appliance is functioning correctly. If the E.S. Control switches off again it is advisable to have the appliance checked by a competent electrician.

CAUTION: In order to avoid a hazard due to inadvertent resetting of the thermal cut out, this appliance **must not be** supplied through an external switching device such as a timer, or connected to a circuit that is regularly switched on and off by the utility.

Maintenance:

WARNING: - Before undertaking any maintenance or cleaning, ensure appliance is disconnected from mains supply. Only competent persons should service / repair appliance.

WARNING: There are no internal user serviceable parts, i.e. bulbs, in this product. Under no circumstance should access be gained to the internal parts other than by a suitably qualified person.

Please note: - If the supply cord on this appliance is damaged it must be replaced by the manufacturer, Authorised Service Agent, or a qualified person to avoid hazard.

General Suite Care – not glass

To maintain the appearance of your new suite we recommend that it is dusted using a lint free cloth. NEVER use any form of abrasives or a DAMP cloth on the surround.

The area around the fire should be kept free of any materials such as lint or house dust (i.e. animal hair/ carpet fibres) that could be drawn into the internal workings of the appliance and affect the performance. We recommend that you clean around the fan grille housing at regular intervals. This can be done using standard vacuum cleaner and suitable attachment.

Glass Care

Periodically it may be necessary to remove the glass screen for cleaning, this is achieved by first disconnecting the appliance from the mains supply, then remove the bracket from the bottom of the glass panel whilst supporting the glass from the front. Once the bracket has been removed the glass screen can be taken out and placed in a clean, soft, safe location for cleaning. When cleaning the glass panel use a slightly damp cloth. Do not use washing powders or any other substance containing abrasives since these substances scratch glass. Refitting is the reversal of this procedure.

Control PCB	Remote Control Receiver	Remote Control Transmitter
Hardware: RC01-040A06 Software: 20171102	Hardware: RF290 V1.2	Frequency: ASK/OOK 433.92MHZ Maximum transmit power: 10mW Hardware:RF290A-TX-V1.3 Software: RF290A_C_V2.4.0.hex

ELECTRIC FIRE GUARANTEE

Hearth Products Ltd (the 'Company') provides a twelve month guarantee in respect of this electric fire appliance.

1. The twelve month Guarantee applies to:

- All 'Products' in the ranges manufactured by the 'Company' (but subject to exceptions below); where
- The 'Product' has been purchased and installed within the UK and in respect of:-
- The initial installation and in favour of
- The original Purchaser

2. Proof of purchase must be retained by the Purchaser

3. The twelve month Guarantee does not apply to:

- Damage or inferior workmanship practices while the 'Product' is being installed
- Damage caused by the mis-use of the 'Product' or where normal standards of care and use have not been complied with
- Damage through a malfunction or an inadequately installed electric fire
- Damage or defects due to, mis-use, accident or unauthorised alterations
- During the twelve month after the 'Product' has been supplied, the Guarantee covers the making good (whether by repair or replacement at the company's discretion) of defects arising from defective manufacture of materials of 'Product' covered in paragraph (1), all at no cost to the Purchaser.

This Guarantee does not affect your statutory rights

On requiring service contact the retailer who supplied your product who will assist you and advise you as necessary.

Be Modern Ltd.
19/34 Bedesway,
Bede Industrial Estate,
Jarrow,
Tyne and Wear
NE32 3BE
Tel: (0191) 430 0901
Fax: (0191) 430 9522
<http://www.bemodern.com>

Environment

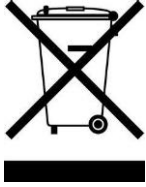

Meaning of crossed –out wheeled dustbin:

Electrical appliances should not be disposed as unsorted municipal waste. Separate collection facilities should be used in the disposal of electrical appliances. Contact your local government for the information about the available collection systems. If electrical appliances are disposed of in landfills or dumps, hazardous substances can leak into the groundwater and get into the food chain, damaging your health and well-being. When old appliances are replaced by the new ones, it is a legal obligation for the retailer to take back the old appliance for disposals at least free of charge.



This fire complies with the Safety Standards EN 60335-1 and EN 60335-2-30 which covers the essential requirements of the Low Voltage Directive 2014/35/EU and the EMC standards EN 55014-1; EN 55014-2; EN 61000-3-2 and EN 61000-3-3 which covers the essential requirements of the European Electro Magnetic Compatibility 2014/30/EU, and the RED standards EN300220 2, EN301489-1, EN301489-3 and EN6247 which covers the essential requirements of the European Radio Equipment Directive 2014/53/EU.



This fire complies with the Safety Standards BS 60335-1 and BS 60335-2-30 which covers the essential requirements of the Electrical Equipment (Safety) Regulations 2016 and the EMC standards BS 55014-1; BS 55014-2; BS 61000-3-2 and BS 61000-3-3 which covers the essential requirements of the Electro Magnetic Compatibility Regulations 2016, and the RED standards BS 300220-2, BS 301489-1, BS 301489-3 and BS 6247 which covers the essential requirements of the Radio Equipment Regulations 2017.



RoHS stands for Restriction of Hazardous Substances, and impacts the entire electronics industry and many electrical products as well. The Restrictions of the Use of Certain Hazardous Substances in Electrical and Electronic Equipment Regulations 2012, originated in the European Union in 2002 and restricts the use of six hazardous materials found in electrical and electronic products. All applicable products in the EU and UK market since July 1, 2006 must pass RoHS compliance.